



ABELL-HOWE CRANES

DIVISION OF CRANE, EQUIPMENT & SERVICE, INC.
 10321 WERCH DR. UNIT 100, WOODRIDGE, ILLINOIS 60517

J-900 WALL BRACKET JIB CRANE

GENERAL ARRANGEMENT
 JB-3F FABRICATED FITTINGS

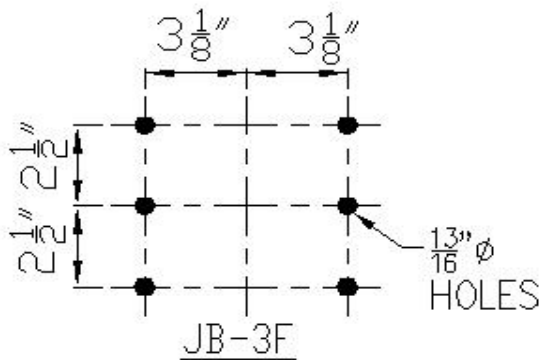
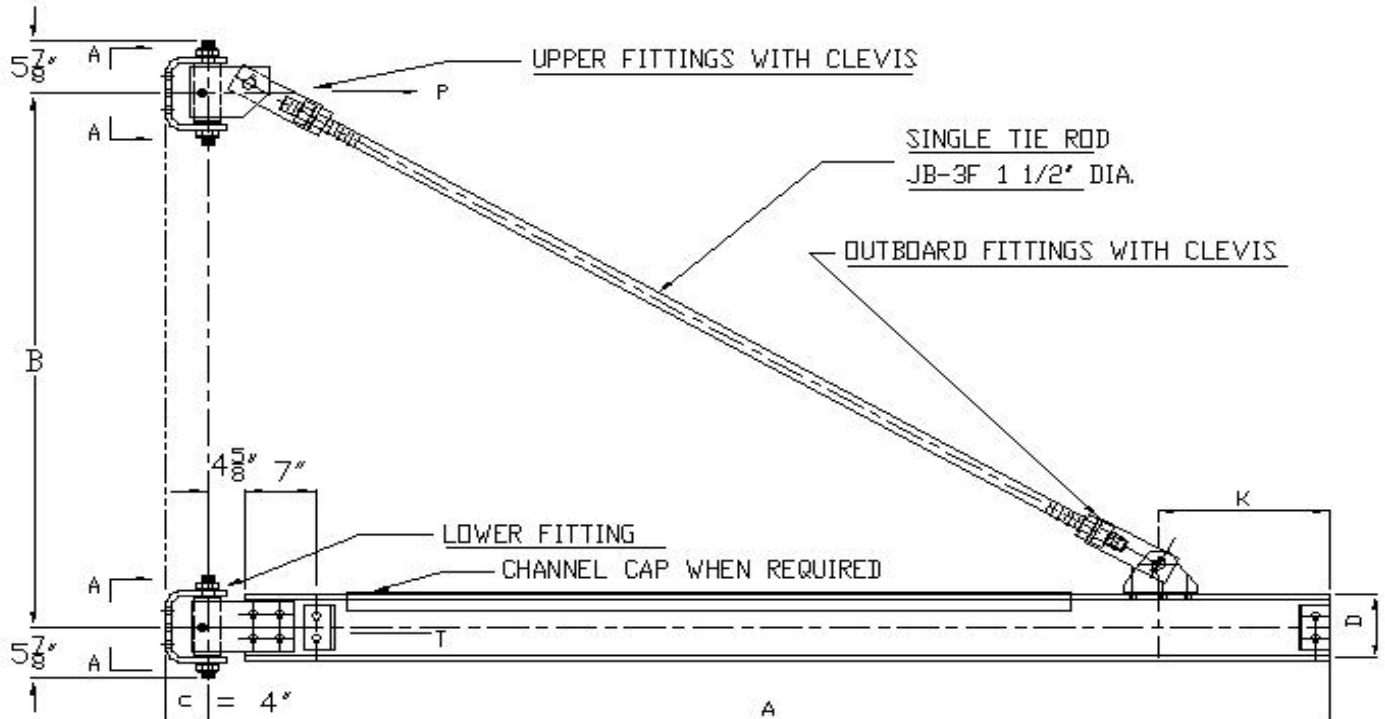

SECTION A-A

NOTE: JIB ASSEMBLY BOLTS & COLUMN CONNECTION BOLTS. TO BE ASTM-A-325 PER A-H CO. RECOMMENDATION.

ABELL-HOWE CRANES, ASSUMES NO RESPONSIBILITY FOR LOADING IMPOSED ON BUILDING STRUCTURE OR FOOTINGS BY THIS EQUIPMENT. WE SUGGEST THIS BE CHECKED BY A LICENSED STRUCTURAL ENGINEER AND ANY NECESSARY PERMITS BE SECURED.

MODEL:	900040
CAPACITY:	3 TON (6,000 #)
A:	14' 0"
B:	4' 9"
C:	4"
D:	W10X26 - D 10 3/8", FW 5 3/4"
K:	2' 0"
NET WEIGHT:	568

SALES NO: _____

CUST. ORDER NO: _____

CUSTOMER: _____

SHIP TO: _____

P = MAX. PULL = 22000

T = MAX. THRUST = 22000